

DC MOTOR SPECIFICATIONS

● SPEED AND LOAD CHARACTERISTICS

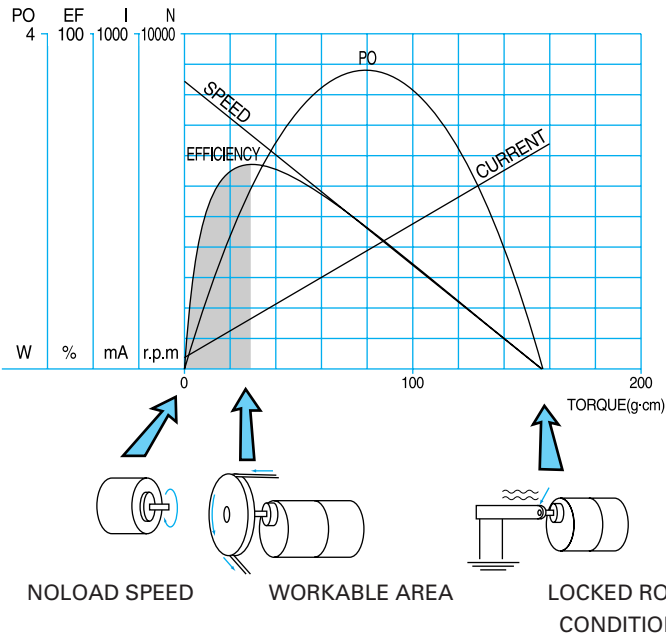

The relationship between torque vs speed and current is linear as shown left; as the load on a motor increases, Speed will decrease. The graph pictured here represents the characteristics of a typical motor.

As long as the motor is used in the area of high efficiency (as represented by the shaded area) long life and good performance can be expected. However, using the motor outside this range will result in high temperature rises and deterioration of motor parts.

If voltage in continuous applied to a motor in a locked rotor condition, the motor will heat up and fail in a relatively short time. Therefore it is important that there is some form of protection against high temperature rises.

A motor's basic rating point is slightly lower than its maximum efficiency point.

Load torque can be determined by measuring the current drawn when the motor is attached to a machine whose actual load value is known.

We will select the most suitable motor for your application after receiving your information.

● AS APPLIED VOLTAGE WILL BE CHANGED

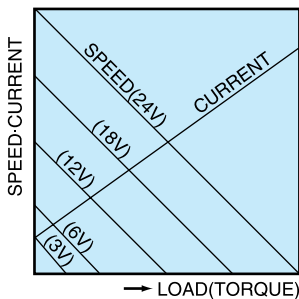

As shown left, if the applied voltage is changed, no load speed and starting torque also change in proportion to the voltage.

Speed characteristics at a given voltage are parallel to those at other voltages.

Thus, a DC motor can be used at a voltage lower than the rated voltage. But, below 1000 rpm, the speed becomes unstable, and the motor will not run smoothly.

● CHARACTERISTICS AND RATED PERFORMANCE OF A GEARED MOTOR

(A) ex. TG-35C MOTOR ONLY

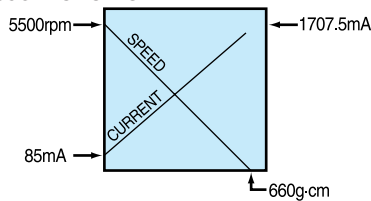

Speed reduction by means of a gear box results in increased torque.

The reduction/increase is determined by the gear ratio and efficiency of the gear box.

(B) WITH 1/75(4-STAGE) GEAR BOX

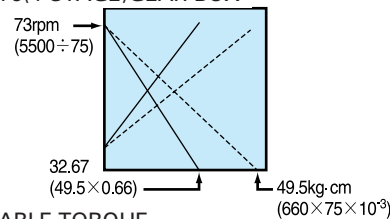

Over-all efficiency depends on the number of reduction stages : one average is 90% per stage. Therefore: a two stage reduction gives 90×90=80%; 3 stages will be 72.9% and a 4-stage reduction 66%.

The above mechanical loss effects the stall torque as shown left.

Stall torque of a geared motor can be calculated using the following formula:

—Motor stall torque × gear ratio × efficiency.

(C) ALLOWABLE TORQUE

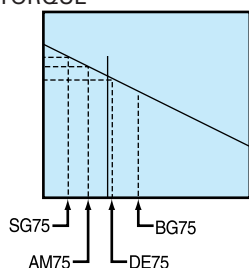

The output loading on a gear box must never exceed the manufactures "specified rated torque" as this will cause premature gear failure.

It is particularly important to observe this at slow output speeds when the calculated output torque exceeds the specified rated torque.

● GEAR BOX CONSTRUCTION AND FEATURES

INTERMITTENT DUTY

(Suitable for less than 2sec.
on & long enough off time)

STANDARD TYPE

AG, SG, BG ⇒
VG, VM, LG

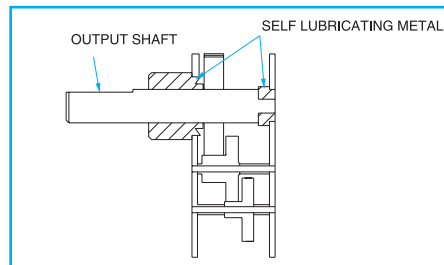

STANDARD GEAR MECHANISM

Other than the output gear, the gears rotate around a shaft that is fixed to the plate.

HEAVY LOAD

—self lubricating metal type.

SM, AM, BE, BM ⇒

—ballbearing at all stages

AP ⇒

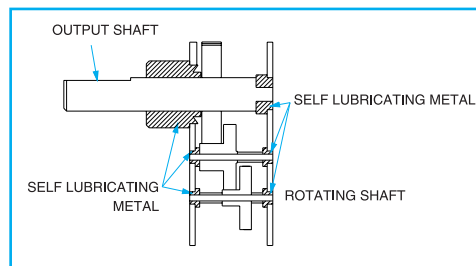

NON-LUBRICATED METAL BEARING GEAR MECHANISM

All gears, including the output gear, are attached to the shaft and supported by non-lubricated metal bearings. This type of mechanism is suitable for medium load applications and continuous duty cycle operation.

LOW COST VERSION—Plastic or sinterd metal. **EU, RU, LG, VG**

COMPACT SIZE TYPE

—Planetary

GU, FU, EU, RU ⇒

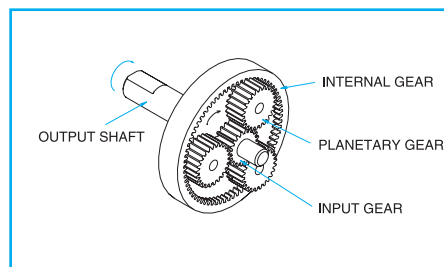

PLANETARY GEAR MECHANISM

A heavy duty type gear mechanism using 3 mating gears to transmit torque to the output shaft. This type of mechanism is suitable for limited space applications.

Protection against overload and locked rotor

When the rotor is locked and voltage is applied to the motor terminals, the temperature of the motor windings will rise and eventually short-circuit.

The time until a short-circuit condition appears differs per motor type.

It is recommended that the motor is protected against such an overload by means of a fuse, current limiter or mechanical protection.

Protection against RFI/EMI caused by PWM control

An internally installed suppressor reduces electrical commutation noise caused by the brushes. Depending on the requirements, extra precautions sometimes are recommended such as an external capacitor, or filter circuit.

When driven in PWM at certain Frequencies it may occur that a motor does not start due to the combination of driving frequency and internally fitted capacitive noise suppressor.

Precautions for instantaneous reversing and dynamic braking

When the power supply to the motor is switched off, it is advisable to allow the motor to stop rotating before reversing the supply polarity.

Failure to do this will result in a very high instantaneous current.

It is possible to stop the motor within a few revolutions by applying a short-circuit across the motor terminals immediately after the motor is switched off. This method is very effective but may shorten brush life.

Vertical mounting with shaft up

In some cases when a motor-gear is mounted in this position, traces of lubrication oil can contaminate the brushes and commutator thus shortening brush life or causing a short-circuit. Please contact us when vertical mounting is required.

Speed detection and control

A number of models can be provided with a magnetic or optical encoder.

Please contact us for detailed information and assistance.

TG-05

(1.7~3.6W) Ø 36, LONG LIFE, LOW NOISE, COMPACT SIZE, ENCODER CAN BE MOUNTED.

APPLICATION: BANKING MACHINE, VENDING MACHINE, MEDICAL EQUIPMENT, DAMPER, PRINTER. etc.

SG/SM

TG-05J
TG-05K
TG-05L/P

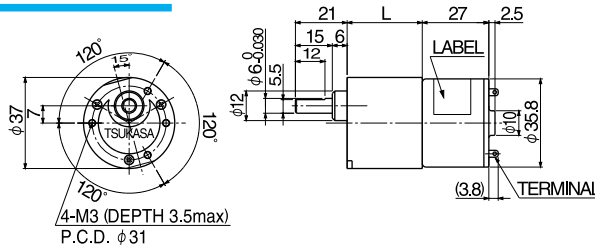

GEAR RATIO	L (mm)	STAGE	TORQUE (kg-cm)	WEIGHT (g)
1/5~1/10	20.5	2	1	100
1/12.5~1/30	23	3	2	105
1/36~1/100	25.5	4	3	110
1/120~1/300	28	5	6	115
1/360~1/1000	30.5	6	6	120
1/1500~1/3000	33	7	6	125

Allowable torque-speed characteristics

MODEL	GEAR RATIO	1 5	1 10	1 15	1 18	1 25	1 30	1 36	1 50	1 60	1 75	1 100	1 120	1 150	1 200	1 250	1 300	1 500	1 750	1 1000	1 1500
TG-05J-SG (24V)	SPEED(r/min)	883	417	279	231	162	136	113	81.3	67.6	54.7	41.5	33.9	27.5	20.4	16.4	14.1	8.9	6.1	4.7	3.2
	TORQUE(mN-m)	9.8	29.4	39.2	49	78.4	88.2	98	137.2	166.6	196	245	294	343	490	588	588	588	588	588	588
	TORQUE(kg-cm)	0.1	0.3	0.4	0.5	0.8	0.9	1	1.4	1.7	2	2.5	3	3.5	5	6	6	6	6	6	6
TG-05K-SG (24V)	SPEED(r/min)	1271	605	404	335	235	198	164	118	98.3	79.5	60.2	49.3	39.9	29.6	23.9	20.4	12.8	8.8	6.7	4.5
	TORQUE(mN-m)	9.8	29.4	39.2	49	78.4	88.2	98	137.2	166.6	196	245	294	343	490	588	588	588	588	588	588
	TORQUE(kg-cm)	0.1	0.3	0.4	0.5	0.8	0.9	1	1.4	1.7	2	2.5	3	3.5	5	6	6	6	6	6	6
TG-05L-SG (24V)	SPEED(r/min)	1643	821	554	462	329	277	230	165	137	113	83.2	68.4	55.6	41.5	33.8	28.8	17.9	12.2	9.3	6.2
	TORQUE(mN-m)	19.6	39.2	49	58.8	88.2	98	107.8	156.8	186.2	196	294	343	392	539	588	588	588	588	588	588
	TORQUE(kg-cm)	0.2	0.4	0.5	0.6	0.9	1	1.1	1.6	1.9	2	3	3.5	4	5.5	6	6	6	6	6	6
TG-05L-SG (12V)	SPEED(r/min)	822	411	269	231	161	134	110	80.6	66.9	53.4	39.9	33.4	26.7	19.9	16.2	13.4	8.3	5.8	4.5	3
	TORQUE(mN-m)	9.8	19.6	29.4	29.4	49	58.8	68.6	88.2	107.8	137.2	186.2	196	245	343	392	490	588	588	588	588
	TORQUE(kg-cm)	0.1	0.2	0.3	0.3	0.5	0.6	0.7	0.9	1.1	1.4	1.9	2	2.5	3.5	4	5	6	6	6	6
TG-05R-SG (12V)	SPEED(r/min)	1185	565	377	313	225	189	156	112	93.8	74.9	56.3	47.4	37.3	28.1	22.6	19.1	11.9	8.2	6.2	4.2
	TORQUE(mN-m)	9.8	29.4	39.2	49	68.6	78.4	88.2	127.4	147	186.2	245	245	343	441	539	588	588	588	588	588
	TORQUE(kg-cm)	0.1	0.3	0.4	0.5	0.7	0.8	0.9	1.3	1.5	1.9	2.5	2.5	3.5	4.5	5.5	6	6	6	6	6
TG-05J-SM (24V)	SPEED(r/min)	883	417	279	231	162	136	113	81.3	67.6	54.7	41.5	33.9	27.5	20.4	16.4	14.1	8.9	6.1	4.7	—
	TORQUE(mN-m)	9.8	29.4	39.2	49	78.4	88.2	98	137.2	166.6	196	245	294	343	490	588	588	588	588	588	—
	TORQUE(kg-cm)	0.1	0.3	0.4	0.5	0.8	0.9	1	1.4	1.7	2	2.5	3	3.5	5	6	6	6	6	6	—
TG-05K-SM (24V)	SPEED(r/min)	1271	605	404	335	235	198	164	118	98.3	79.5	60.2	49.3	39.9	29.6	23.9	20.4	12.8	8.8	6.7	—
	TORQUE(mN-m)	9.8	29.4	39.2	49	78.4	88.2	98	137.2	166.6	196	245	294	343	490	588	588	588	588	588	—
	TORQUE(kg-cm)	0.1	0.3	0.4	0.5	0.8	0.9	1	1.4	1.7	2	2.5	3	3.5	5	6	6	6	6	6	—
TG-05L-SM (24V)	SPEED(r/min)	1643	821	554	462	329	277	230	165	138	113	83.2	68.4	55.6	41.5	33.8	28.8	17.9	12.2	9.3	—
	TORQUE(mN-m)	19.6	39.2	49	58.8	88.2	98	107.8	156.8	186.2	196	294	343	392	539	588	588	588	588	588	—
	TORQUE(kg-cm)	0.2	0.4	0.5	0.6	0.9	1	1.1	1.6	1.9	2	3	3.5	4	5.5	6	6	6	6	6	—
TG-05L-SM (12V)	SPEED(r/min)	822	411	269	231	161	134	110	80.6	66.9	53.4	39.9	33.4	26.7	19.9	16.2	13.4	8.3	5.8	4.5	—
	TORQUE(mN-m)	9.8	19.6	29.4	29.4	49	58.8	68.6	88.2	107.8	137.2	186.2	196	245	343	392	490	588	588	588	—
	TORQUE(kg-cm)	0.1	0.2	0.3	0.3	0.5	0.6	0.7	0.9	1.1	1.4	1.9	2	2.5	3.5	4	5	6	6	6	—
TG-05R-SM (12V)	SPEED(r/min)	1185	565	377	313	225	189	156	112	93.8	74.9	56.3	47.4	37.3	28.1	22.6	19.1	11.9	8.2	6.2	—
	TORQUE(mN-m)	9.8	29.4	39.2	49	68.6	78.4	88.2	127.4	147	186.2	245	245	343	441	539	588	588	588	588	—
	TORQUE(kg-cm)	0.1	0.3	0.4	0.5	0.7	0.8	0.9	1.3	1.5	1.9	2.5	2.5	3.5	4.5	5.5	6	6	6	6	—

AG/AM

TG-05J
TG-05K
TG-05L/P

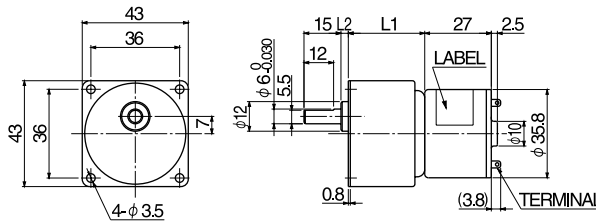

GEAR RATIO	L1 (mm)	L2 (mm)	STAGE	TORQUE (kg-cm)	WEIGHT (g)
1/5~1/10	26	0.5	2	1	90
1/12.5~1/30	26	3	3	2	95
1/36~1/100	26	5.5	4	3	100
1/120~1/300	31	3	5	6	105
1/360~1/1000	31	5.5	6	6	110
1/1500~1/3000	31	8	7	6	115

Allowable torque-speed characteristics

MODEL	GEAR RATIO	1 5	1 10	1 15	1 18	1 25	1 30	1 36	1 50	1 60	1 75	1 100	1 120	1 150	1 200	1 250	1 300	1 500	1 750	1 1000	1 1500
TG-05J-AG (24V)	SPEED(r/min)	883	417	279	231	162	136	113	81.3	67.6	54.7	41.5	33.9	27.5	20.4	16.4	14.1	8.9	6.1	4.7	3.2
	TORQUE(mN-m)	9.8	29.4	39.2	49	78.4	88.2	98	137.2	166.6	196	245	294	343	490	588	588	588	588	588	588
	TORQUE(kg-cm)	0.1	0.3	0.4	0.5	0.8	0.9	1	1.4	1.7	2	2.5	3	3.5	5	6	6	6	6	6	6
TG-05K-AG (24V)	SPEED(r/min)	1271	605	404	335	235	198	164	118	98.3	79.5	60.2	49.3	39.9	29.6	23.9	20.4	12.8	8.8	6.7	4.5
	TORQUE(mN-m)	9.8	29.4	39.2	49	78.4	88.2	98	137.2	166.6	196	245	294	343	490	588	588	588	588	588	588
	TORQUE(kg-cm)	0.1	0.3	0.4	0.5	0.8	0.9	1	1.4	1.7	2	2.5	3	3.5	5	6	6	6	6	6	6
TG-05L-AG (24V)	SPEED(r/min)	1643	821	554	462	329	277	230	165	137	113	83.2	68.4	55.6	41.5	33.8	28.8	17.9	12.2	9.3	6.2
	TORQUE(mN-m)	19.6	39.2	49	58.8	88.2	98	107.8	156.8	186.2	196	294	343	392	539	588	588	588	588	588	588
	TORQUE(kg-cm)	0.2	0.4	0.5	0.6	0.9	1	1.1	1.6	1.9	2	3	3.5	4	5.5	6	6	6	6	6	6
TG-05L-AG (12V)	SPEED(r/min)	822	411	269	231	161	134	110	80.6	66.9	53.4	39.9	33.4	26.7	19.9	16.2	13.4	8.3	5.8	4.5	3
	TORQUE(mN-m)	9.8	19.6	29.4	29.4	49	58.8	68.6	88.2	107.8	137.2	186.2	196	245	343	392	490	588	588	588	588
	TORQUE(kg-cm)	0.1	0.2	0.3	0.3	0.5	0.6	0.7	0.9	1.1	1.4	1.9	2	2.5	3.5	4	5	6	6	6	6
TG-05R-AG (12V)	SPEED(r/min)	1185	565	377	313	225	189	156	112	93.8	74.9	56.3	47.4	37.3	28.1	22.6	19.1	11.9	8.2	6.2	4.2
	TORQUE(mN-m)	9.8	29.4	39.2	49	68.6	78.4	88.2	127.4	147	186.2	245	245	343	441	539	588	588	588	588	588
	TORQUE(kg-cm)	0.1	0.3	0.4	0.5	0.7	0.8	0.9	1.3	1.5	1.9	2.5	2.5	3.5	4.5	5.5	6	6	6	6	6
TG-05J-AM (24V)	SPEED(r/min)	883	417	279	231	162	136	113	81.3	67.6	54.7	41.5	33.6	27.4	20.4	16.2	13.8	8.9	—	—	—
	TORQUE(mN-m)	9.8	29.4	39.2	49	78.4	88.2	107.8	137.2	166.6	196	245	343	392	490	637	686	686	—	—	—
	TORQUE(kg-cm)	0.1	0.3	0.4	0.5	0.8	0.9	1.1	1.4	1.7	2	2.5	3.5	4	5	6.5	7	7	—	—	—
TG-05K-AM (24V)	SPEED(r/min)	1271	605	404	335	235	198	165	118	98.3	79.5	60.2	48.9	39							